



UNIBLOCK™ UBTD+
Diesel Rotary UPS



PILLER
Power Systems

Nothing protects quite like Piller

UNIBLOCK™ UBTD+



Piller headquarters, Osterode, Germany

About Piller

Founded in Hamburg, Germany over 100 years ago by Anton Piller, the company has a long history in the manufacturing of exceptionally high quality electrical machines and power quality equipment.

Today, Piller is a world leader and innovator in a number of power protection technologies, specialising in UPS systems for 'mission critical' applications and Frequency Converters for Aircraft Ground Power amongst other uses. For the past 30 years, the company has designed and manufactured static technology products alongside its rotary counterparts, giving it a unique position with widespread specialist capabilities for today's power protection clients.

Piller UPS systems are found in colocation data centres, financial institutions, broadcasting, telecommunication networks, airports, healthcare facilities, continuous process production sites and applications where high quality power is paramount.

Piller Frequency Converters and related products are prevalent in both military and civil applications, providing 400Hz ground power at airports, 50/60Hz ship-to-shore supplies in ports and on-board power systems for both submarine and surface vessels.

Since 1919, Osterode in Germany has been the home of Piller Research, Development and Manufacturing in a state-of-the-art facility where all products can be seen in the making, from raw material through to finished goods. The Piller Group is a part of the family of leading engineering companies belonging to the British multi-discipline group Langley Holdings plc. (www.langleyholdings.com).

Power around the clock, around the world

Power quality varies dramatically around the world. In some regions, adverse weather leads to regular power supply disturbances and total failures. In others, poor infrastructure causes voltage drops, frequency instability and outages. In addition, the electrical characteristics of loads place a variety of demands on the power source.

For industrial applications, there will often be extremely high power requirements spread across large sites, rapidly changing high current loads or the need for long term outage support. Not only that, ownership and running costs of any solution have to be factored in to the manufacturing or processing costs.

IT applications like data centres, on the other hand, often have a different focus, with loads that are less dynamic but where performance specifications are more precise and high operational efficiency combined with maximum uptime is paramount.

Whatever the situation, facility designers have an obligation to end users to develop a technical solution which minimises risk whilst optimising whole life costs. At the same time, the final solution must be practical for maintenance and versatile enough to be future proofed.

The new Piller UNIBLOCK™ UBTD+ family is exactly that kind of UPS, combining state of the art machine technology and electronics to deliver outstanding reliability, efficiency, flexibility and performance.

Introducing the UNIBLOCK™ UBTD+

The UBTD+ is unlike any other UPS. Consisting of a special combination of proprietary motor-generator and choke, this UPS provides a very simple and highly reliable uninterruptible power solution with exceptionally high efficiencies.

The technology employed provides an extremely robust, small footprint, high power solution designed to give over 20 years of dependable operation. The UBTD+ is available in single module sizes from 500kW to 2700kW with options available in terms of energy storage and diesel engine thereby offering versatility to meet the specific conditions and load requirements. With the UNIBLOCK™ UBTD+ multiple system configurations are readily possible. Paralleling is simple, modular expansion is easy and there are solutions for every size of installation.

UBTD+ has the highest design flexibility:

- Low and medium voltage systems
- Ride-through energy from batteries or kinetic storage
- Cooling by air or chilled water
- Containerised solutions
- Delayed or instant diesel starting
- Sophisticated load-dependent management options

Mission Critical Power

Principle of Operation

The UNIBLOCK™ UBTD+ Diesel Rotary UPS combines all the benefits of a rotary UPS with a diesel engine in one integrated unit.

The system consists of the UNIBLOCK™ motor-generator (MG) connected via a free wheel clutch to a diesel engine, all mounted on a single short base frame. The load is normally fed via an isolating and coupling choke connected to the utility supply. The choke has a second tapped connection to the motor-generator. In the event of short interruptions or complete outages, the load is supported initially by a ride-through source which can be either a conventional battery system or a Piller POWERBRIDGE™ electrically-coupled kinetic energy store – alternatives unique to the Piller design and providing the longest ride-through times available in the market. With the load safely supported, the diesel engine is then given a command to start. Once up to speed, the system hands over the long-term support of the load to the engine by seamlessly engaging the clutch.

The UNIBLOCK™ Motor-Generator

At the heart of every Piller Rotary UPS lies the pre-eminent UNIBLOCK™ synchronous motor-generator with its unique low-distortion, high fault-clearing characteristics.

The UNIBLOCK™ machine's motor and generator windings share a common stator and a single brushless rotor to provide a highly compact double winding machine with unique electrical characteristics. The combination of special electric steel and combined stator windings gives rise to a machine with exceptionally high efficiency whilst exhibiting the sub-transient reactance required for low harmonic distortion and high fault clearing capacity. An incorporated damper cage reduces harmonics and the standard bearing design ensures long operational performance with minimal maintenance. The machine is manufactured and balanced by hand at the Piller factory to ensure extremely long service life.

System Reliability

A design free of power capacitors eliminates the common failure component generally found in static UPS. The durable rotary machine technology is far less sensitive to damage from overload and other electrical disturbances and uses no brushes, slip rings or complex bearing arrangements.

The power electronics employ rugged semiconductor technology with no need for internal device paralleling or multiple power capacitors. Bypass operation is not required for any aspect of the UPS function and in most cases, electric cooling fans are eliminated by using the impeller of the UNIBLOCK™ machine for the system cooling. All of these factors combine to provide a UPS which exhibits a level of reliability that cannot be matched by other technologies.

Power Quality Improvement

The UBTD+ will compensate for the supply of very low input voltages, including voltage sags to 50% of nominal voltage, without disconnection. It can protect against brownouts to -30% without even having to use the ride-through stored energy.

The unit easily handles 100% non-linear loads as well as 100% step loads while maintaining a stable output. Acting as a bi-directional filter inside the UPS, the choke eliminates the passage of nearly all harmonics between load and source.

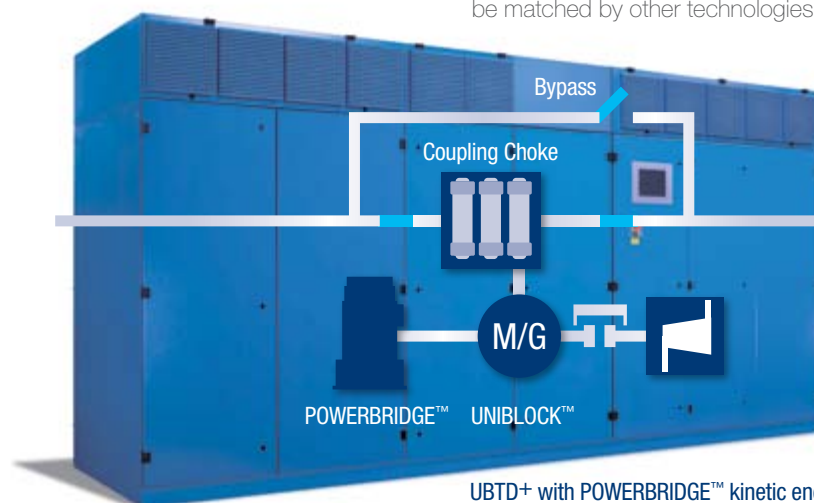

UBTD+ with POWERBRIDGE™ kinetic energy store.

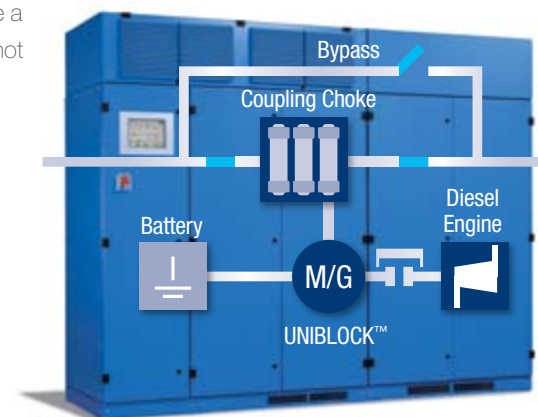

UBTD+ with external battery ride-through.



UNIBLOCK™ UBTD+

Power Factor Correction

Power factor correction is automatic with the UBTD+. The MG and choke combination compensates for poor power factor loads so that the utility sees near unity across all load levels. This means no electricity tariff penalties need apply and additional power factor correction units are not required.

Fault Handling

The UBTD+ is inherently capable of clearing short circuit faults by virtue of extremely low sub-transient reactance, that approximates towards normal

supply transformer impedances, ensuring fault-clearing current can be generated internally by the UPS. This capability represents a step improvement in fault tolerance of the power system when compared for example, to a conventional static UPS solution.

Simple Maintenance

Nothing in the standard UBTD+ design requires off-site refurbishment and the maintenance requirements are less than most alternative topologies, with no power capacitors or fans to be periodically changed. Life expectancy of the UNIBLOCK™ easily exceeds 20 years.

UNIBLOCK™ UBTD+ features

- Single machines sized 500kW up to 2700kW
- Paralleling up to 40MW
- Higher reliability than other technologies
- Highest partial and full load efficiencies with energy store connected
- Total design flexibility
- Medium and low voltage options
- Battery or kinetic energy store versions
- Typically 3 times longer bridging time from the POWERBRIDGE™ compared with other UPS
- Fastest recharge time with POWERBRIDGE™
- Wide leading and lagging load power factor without de-rating
- Inherent fault clearing ability for downstream short circuits
- Virtual unity input power factor
- 99% input/output harmonic isolation
- Small footprint and high power density
- Simple maintenance requirements

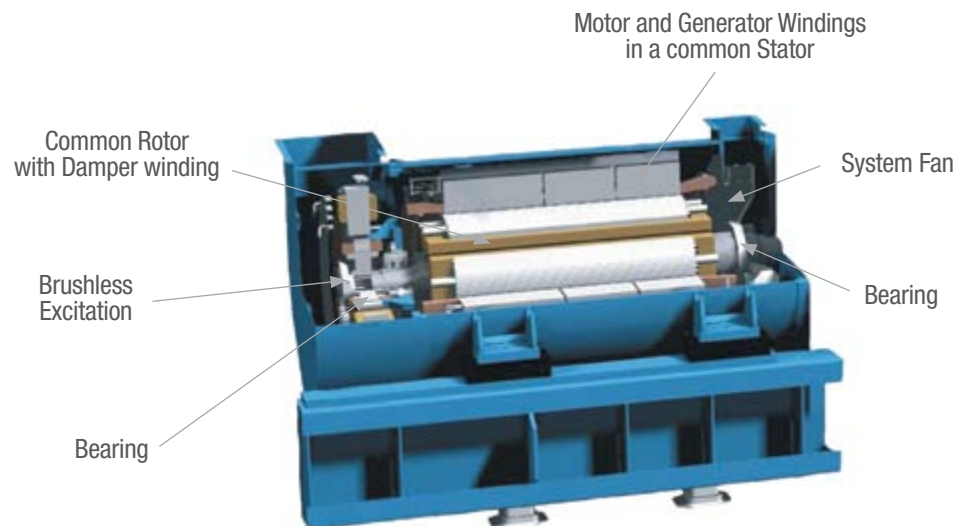

Energy storage solutions

POWERBRIDGE™ Option

Piller's electrically-connected kinetic energy storage option offers designers the chance to save space and maximise power density per unit.

The POWERBRIDGE™ comprises a vertically-mounted synchronous generator whose rotor is connected to a flywheel to provide the energy storage. Whenever stored energy is needed, it is discharged through the generator into a converter stage that ensures a stable frequency into the UNIBLOCK™ motor-generator. Recharge works similarly in the opposite direction.

With a POWERBRIDGE™, stored energy levels are guaranteed, air-conditioned battery rooms can be avoided and there is no environmental disposal issue to manage in the future.

Significantly, a POWERBRIDGE™ can absorb energy at the same rate as it can dissipate and can do so on an indefinite basis. No other electrical storage solution can equal this. This capability acts as a cushion for the engine so as to provide unequalled frequency stability under dynamic load conditions. Magnetic-lift technology significantly

reduces forces on the main bearings, resulting in extremely high efficiency. This also serves to extend the bearing life ensuring many years of continuous operation.

A vertically mounted flywheel and generator utilising magnetic bearing technology, the POWERBRIDGE™ is available in a number of sizes for different power ratings and ride-through autonomy.

Battery Option

The Piller UNIBLOCK™ UBTD+ is also available with an option where batteries are used to provide the ride-through energy. While the electrical efficiency of a battery solution is superior to any equivalent kinetic energy solution, there is a trade off against space and other key factors. However, the longer and customised autonomy of batteries offers the advantage of further limiting diesel engine starts which may be required in certain applications.

The UNIBLOCK™ system is extremely battery-friendly, helping to maximise battery service life and reduce costs as the batteries are not subject to constant harmful DC ripple currents from rectifier-inverter operation.



Top bearing

Brushless excitation

Main machine

Flywheel

Bottom bearing



Other design solutions

Water-cooled benefits:

- Higher efficiency in the plant room
- Capable of operation in harsh environments
- Reduced investment costs
- Lower operating costs
- Smaller space requirement
- Quieter operation

Cross section of water-cooled unit

- A:** The enclosed air circuit is operated by an internal fan impeller incorporated in the rotor of the electrical machine
- B:** The UNIBLOCK™ with built in water cooling is connected to the chilled water circuit of the building.

UNIBLOCK™ UBTD+ Water-Cooled Option

The UBTD+ can be naturally cooled with the UNIBLOCK™ impeller ducting the warm air straight to the outside world. When site restrictions make this impossible, the plant room can either be force-cooled or alternatively, the UBTD+ can be provided with its own heat exchanger directly connected to the building's chilled water supply.

In this configuration, each UBTD+ unit has a closed air cooling circuit that passes via a heat exchanger cabinet integrated at the end of the UPS. With the cooling unit providing the UPS with its own climate the UPS can be operated in small rooms, in harsh environments or in areas where quiet operation is required. Without the need for external forced cooling, complex plant room airflow studies can be eliminated, space can be saved and maintenance routines simplified.

UNIBLOCK™ UBTD+ Containerised

The Piller UNIBLOCK™ UBTD+ can be installed in a plant room or supplied complete from the factory as a containerised unit. All components necessary for operation are integrated into the container, making the Piller UNIBLOCK™ UBTD+ a transportable UPS system ready to be set to work wherever a project programme better suits off-site construction or wherever utilisation of the building space needs to be maximised.

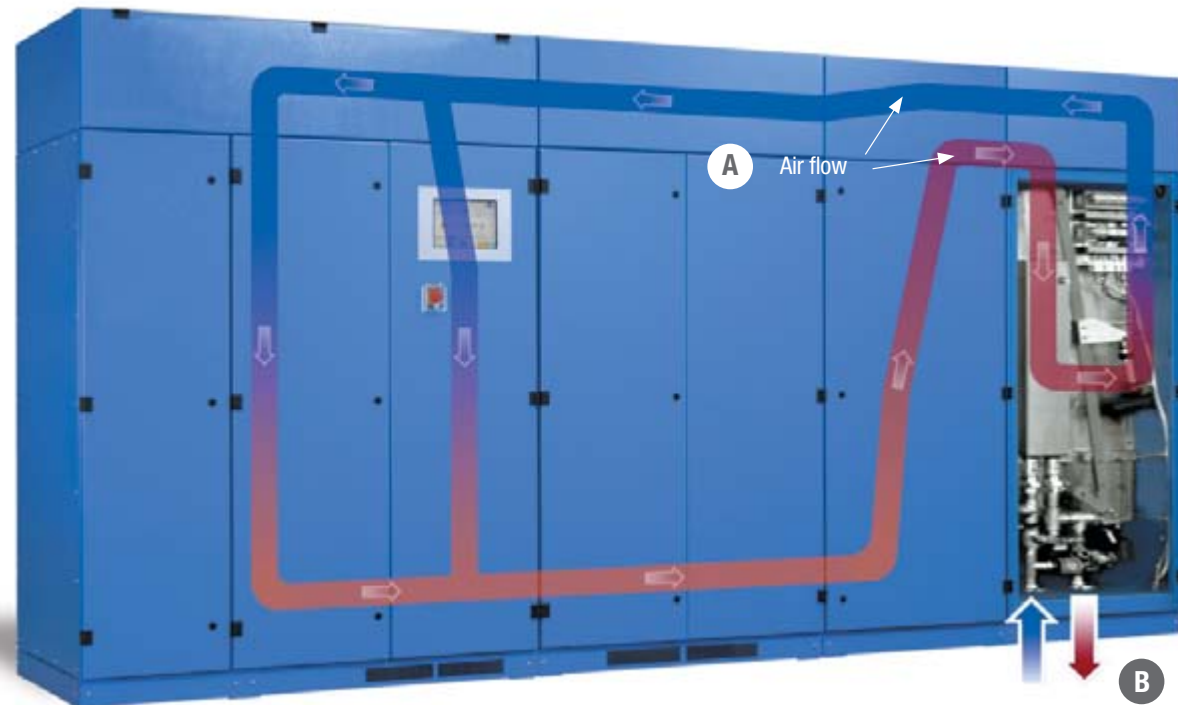

Optimised protection

Containerised benefits:

- Operating readiness immediately on connecting to the mains
- No structural measures for noise attenuation, ventilation or cabling
- Minimal expenditure for on-site testing and commissioning
- No outlay on complex installation or plant room construction
- Temporary use in different locations or use in modular expansion
- Reduced on site programmes

Enhanced Diesel Engine Starting

Research shows that in most utility supplies, mains disturbances lasting more than 10ms occur almost daily, jeopardising or substantially disrupting the operation of electrical equipment.

In a typical overhead network system, over 60% of all mains failures last more than 100ms and yet only some 2% continue for more than a few seconds. In countries where the power supply system is still developing, the statistics show more outages, which also tend to be longer.

Thanks to the POWERBRIDGE™, the unique design of the Piller UNIBLOCK™ UBTD+ gives an extended ride-through capability with no need to start up the diesel generator for the majority of mains disturbances. This can reduce the number of false generator starts to practically none, compared with around 5 starts per week with other diesel UPS solutions.

The Piller Diesel UPS system's ability to ride through nuisance disturbances without a generator start comes from the large storage capacity available

within its POWERBRIDGE™. Where other diesel UPS solutions need virtually all of their stored energy just to run the generator up to speed and take over the load, the stored energy of the Piller UNIBLOCK™ UBTD+ removes the need to start the engine except for the longest of outages, which could be seconds, or even minutes.

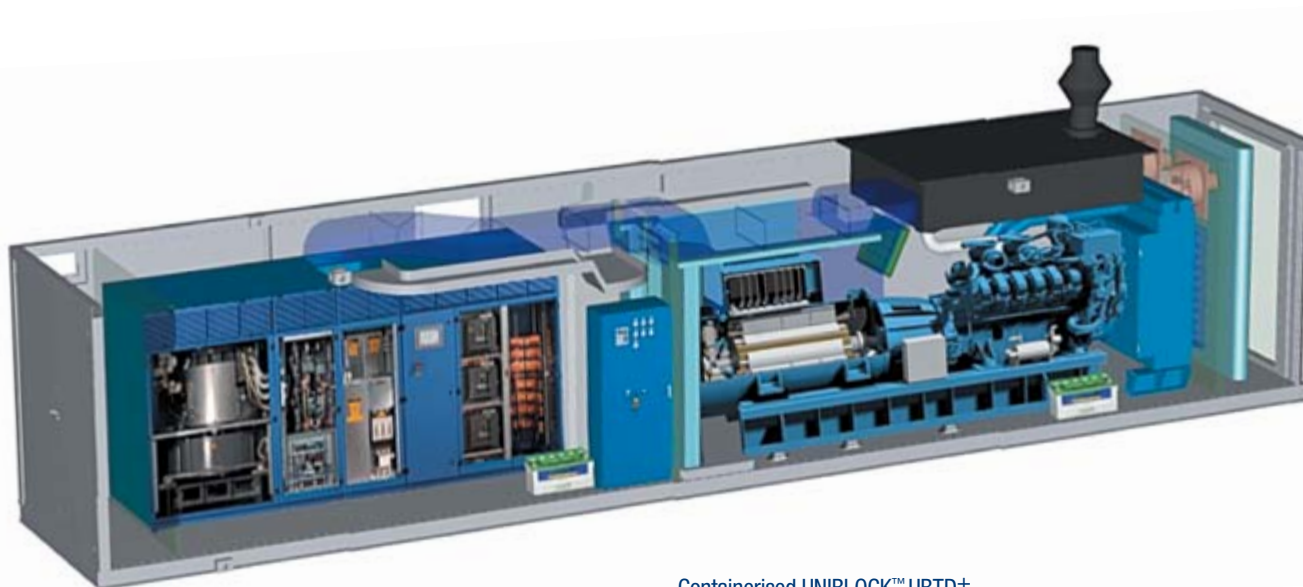

Containerised UNIBLOCK™ UBTD+.

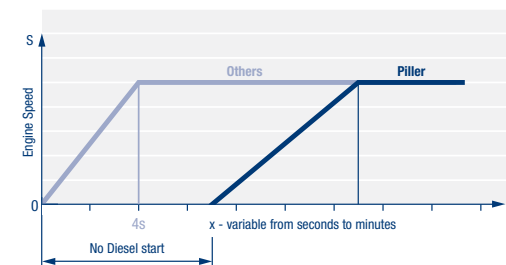
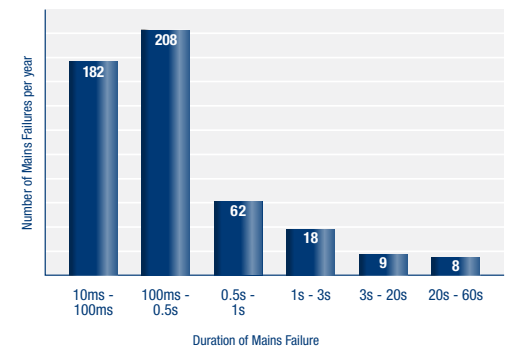



Unit configurations

The UNIBLOCK™ UBTD+ UPS

In its basic form, the Piller UBTD+ provides 100% of its available output as continuous uninterruptible power. In alternative forms, the power is split between UPS (Critical Bus) power and Short-Break power (similar to a standby generator). This is known as Dual Output Bus.

Depending upon the particular design requirements, it is sometimes necessary or desirable to isolate the short-break loads from the Critical Bus – this is known as Dual Output Isolated Bus. In this configuration, the generator winding provides the Critical Bus source and the motor winding of the UNIBLOCK™ machine becomes a generator for

the Short-Break Bus. The two circuits are isolated by virtue of the transformer action between the windings and so the two outputs are electrically isolated. In other circumstances, use of the same alternator for both supplies may be a preferred option, particularly in MV solutions.

Isolated Redundant Configuration

Traditionally, where redundancy was required a parallel redundant configuration would be used. With an isolated redundant configuration, redundancy is created on the basis of standard single units. All individual units support their individual critical loads. In an 'N+1' configuration, these systems have one redundant unit as a

backup. This backup unit normally operates in a no-load condition. In the event that one unit fails or is taken off-line, the critical loads are automatically transferred to the redundant unit via seamless change-over instead of going to bypass.

Additionally, some non-critical load can be connected to the redundant unit utilising the available diesel UPS power. Compared to the parallel redundant configurations at low voltages, this configuration can be used for much higher system power ratings without the need to adopt medium voltages.

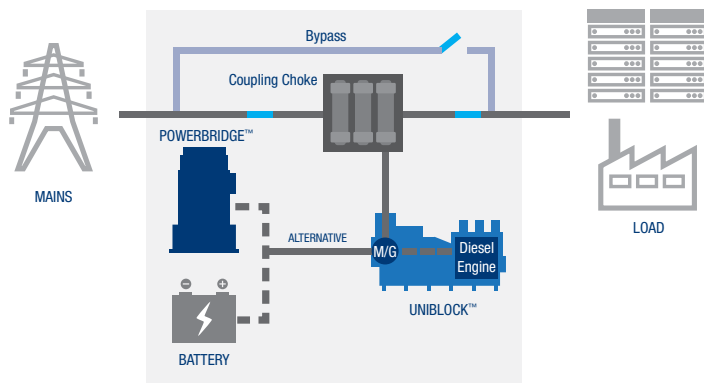

UNIBLOCK™ UBTD+ in standard output configuration.

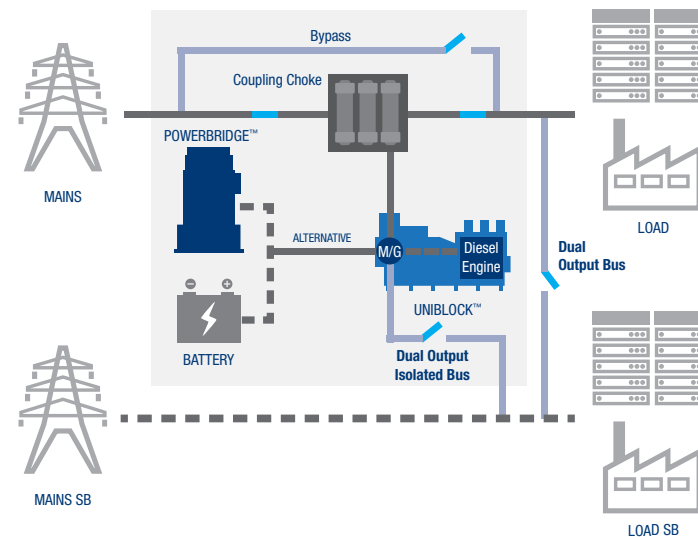

UNIBLOCK™ UBTD+ with alternative Dual Output Bus configurations.

System configurations

Distributed Redundant Configuration

In the isolated redundant configuration, the redundant unit normally supplements a non-critical load, or runs with no load; this arrangement can be enhanced with the distributed redundant concept. Distributed redundant systems are normally designed for 'N+1' redundancy. No single module is assigned as a redundant unit. Instead, this role is shared equally among all modules. In the event of a single unit failure, its load will be shared proportionately over the remaining units.

The load transfers are accomplished through automatic transfer switches and/or via dual corded equipment. The advantages are the elimination of single point failures and equal load sharing among all units.

The UBTD+ in High Power Applications

The UNIBLOCK™ UBTD+ is available for high power applications with unit sizes ranging from 500kW up to 2700kW. In medium voltage systems, the units can be paralleled to 40MW, either with individual or common coupling chokes. At low voltages, simple paralleling is limited to about 5MW but there are configurations using fault isolated parallel techniques that allow this to be increased reliably and safely to 20MW.

Isolated Parallel (IP) Configuration

The isolated-parallel system uniquely enables the advantages of combining isolated-redundant and parallel-redundant UPS configurations. This means that very large 'N+1' redundant electrical systems can be created at low voltage without excessive fault currents and that at any voltage, the configuration can be concurrently maintainable. By reducing the redundant UPS units to a minimum and avoiding systems which run in the standby mode the IP system is an excellent choice for optimising the combination of redundancy, resilience, maintainability and cost.

Other UNIBLOCK™ Configurations:

- System + System
- Hot-Stand-by
- Parallel Redundant

The UNIBLOCK™ UBTD+ can be paralleled up to 40MW in an IP-Bus System.

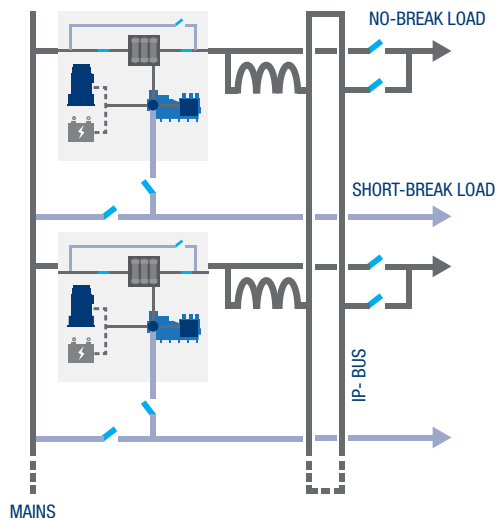



Total Cost of Ownership

Owning and operating a data centre or large scale industrial process plant is an expensive business; the cost of real estate and energy may heavily influence the final design and the location of the facility. Add to that the pressures of designing an environmentally friendly solution and the restrictions become even greater. First and foremost, a UPS must be reliable. Secondly, it should deliver an optimised total cost of ownership (or TCO) over its useful life.

The TCO for a UPS is a combination of the capital expense, the electrical operating costs, the routine maintenance and the periodic overhaul or replacement. It is also dependent upon the requisite surrounding infrastructure (building space, running costs, capital costs for switchgear, transformers, cabling, power factor correction and cooling). In most TCO calculations, the dominant factor is the electrical running cost of the entire system rather than capital costs or maintenance.

A TCO analysis incorporating the UNIBLOCK™ UBTD+ system compares favourably with other solutions because of the combination of its characteristics:

- High electrical efficiency
- Very simple, economic maintenance and overhaul
- Elimination or reduction of air conditioning requirements
- Reduced space requirement
- Cyclic maintenance and care work is all undertaken on site
- Reduced engine wear by minimised starting
- Natural cooling capability

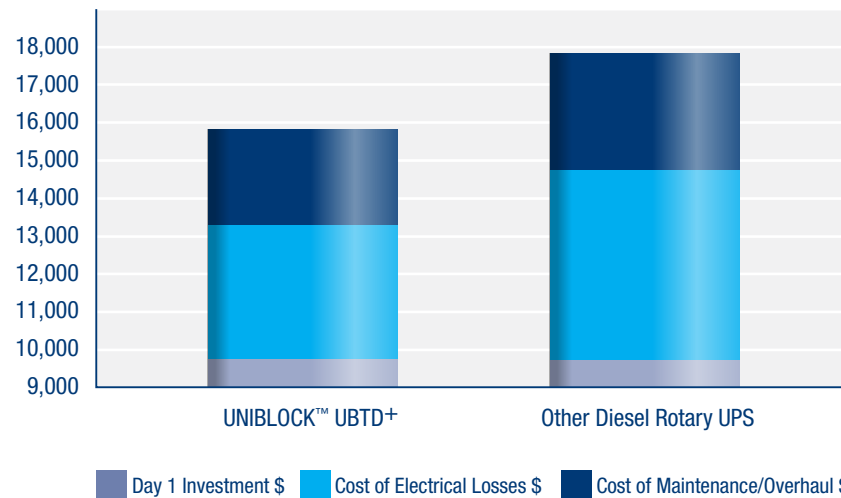

TCO comparison by Expense Category (DCF)

Taking care of your investment

After Sales Service

Piller believes it is simply not enough to manufacture a first class product with inherent high reliability. A UPS system must protect the client's interests just as well on its last day as it does on its first, which is why Piller offers a worldwide network for the professional care of its clients' investments in Piller UPS technology, deploying a team of highly trained and internationally co-ordinated technicians.

The team takes care of over 9000 units of high power UPS equipment in over 40 countries, supporting clients' activities in data processing, banking and finance, industry, communications, aviation and defence, 24 hours a day, 365 days a year.

Emergency Response Service

Sometimes, support and expertise is needed when you least expect it. For those times, you can be assured that help will be available in the shortest possible time. Piller Service Centres are strategically positioned to provide local knowledge of the client's installation and the best possible response time. Piller offers 24 hour emergency response with technicians on standby for immediate dispatch at each of its service centre locations.

Preventative Maintenance Service

Periodic preventative maintenance in accordance with well-defined Piller standards ensures security of supply to critical equipment as well as minimising malfunctions and extending the life of the UPS system to 20 years or more.

Parts Availability

Piller preventative maintenance and emergency response services are fully supported by a network of stocked parts held both at the service centres and elsewhere in strategic locations around the world.

Consultation and Other Services

Ever changing demands in business can lead to the need for alteration, expansion or redeployment of a UPS system. In such cases, Piller's technical support teams will evaluate the requirements and advise on necessary changes. They can also manage the delivery of these changes, consulting with clients and their partners to ensure minimal disruption.

- Replacement battery systems
- Reconfiguration and redeployment
- Upgrades
- Remote monitoring systems
- Site surveys

Operator Training

All newly installed systems will involve a degree of operator training conducted either on site or in one of Piller's training centres. Piller offers further refresher courses to ensure that client staff or their appointed operational representatives have the skills necessary to operate the UPS system with minimum risk.





HEADQUARTERS
Piller Group GmbH
Abgunst 24
37520 Osterode
Germany
E: info@piller.com

ROTARY UPS SYSTEMS
HYBRID ROTARY UPS SYSTEMS
DIESEL ROTARY UPS SYSTEMS
STATIC UPS SYSTEMS
STATIC TRANSFER SWITCHES
KINETIC ENERGY STORAGE
AIRCRAFT GROUND POWER SYSTEMS
FREQUENCY CONVERTERS
NAVAL POWER SUPPLIES
SYSTEM INTEGRATION

piller.com



A Langley Holdings Company



Piller Australia Pty. Ltd.
2/3 Salisbury Road,
Castle Hill,
New South Wales 2154,
Australia
T: +61 2 9894 1888
F: +61 2 9894 2333
E: australia@piller.com

Piller France SAS
107-111 Av Georges
Clémenceau,
B.P. 908, F-92009 Nanterre
Cedex, France
T: +33 1 47 21 22 55
F: +33 1 47 24 05 15
E: france@piller.com

**Piller Germany
GmbH & Co. KG**
Abgunst 24,
37520 Osterode,
Germany
T: +49 5522 311 0
F: +49 5522 311 414
E: germany@piller.com

Piller Italia S.r.l.
Centro Direzionale Colleoni,
Palazzo Pegaso 3,
Viale Colleoni 25, 20041
Agrate Brianza (MB), Italy
T: +39 039 689 2735
F: +39 039 689 9594
E: italia@piller.com

Piller Iberica S.L.U.
Paseo de la Habana,
202 Bis Bj,
E-28036 Madrid, Spain
T: +34 91 345 86 58
F: +34 91 350 16 33
E: spain@piller.com

**Piller Power
Singapore Pte. Ltd.**
25 International Business Park,
#01-65/66 German Centre,
Singapore 609916
T: +65 6562 9100
F: +65 6562 9109
E: asiapac@piller.com

Piller UK Ltd.
Westgate, Phoenix Way,
Cirencester,
Gloucestershire, GL7 1RY,
United Kingdom
T: +44 1285 657 721
F: +44 1285 654 823
E: uk@piller.com

Piller USA Inc.
45 Turner Drive,
Middletown,
New York 10941-2047
USA
T: +1 800 597 6937
F: +1 845 692 0295
E: usa@piller.com

Representatives and Distributors in:

ALGERIA | ARGENTINA | AUSTRIA | BAHRAIN | BELGIUM | BRASIL | CANADA | CHILE | CHINA | DENMARK | ESTONIA | FINLAND |
HONG KONG | HUNGARY | INDIA | INDONESIA | IRAN | JAPAN | KOREA | LATVIA | LITHUANIA | MALAYSIA | NETHERLANDS |
NIGERIA | NORWAY | PERU | PHILIPPINES | POLAND | ROMANIA | RUSSIA | SERBIA | SLOVENIA | SOUTH AFRICA | SWEDEN |
SWITZERLAND | SYRIA | TAIWAN | THAILAND | TURKEY | UAE | UKRAINE | USA

Piller UBTD+ GB August 2013/Issue 1

The information contained within this brochure is deemed to be correct at the time of going to press. Due to a policy of continued improvement, we reserve the right to change any specification without prior notice. ERRORS & OMISSIONS EXCEPTED.